

CEMENT BOARD FABRICATORS



Product Guide

III AD Architects & Design, www.3-ad.com Spitzack/Vice photo by Jayme Halbritter Photography



CRFORMA design::build

CRFORMA design::build

2148 S. 41st Street • Louisville, KY 40211 • 1-800-366-5378 • www.cementboardfabricators.com

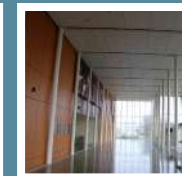

CRFORMA design::build

CRFORMA design::build

Jim Burton Architects
[www.blipdesign.com]
photo by Art Grice

Revised 5-26-2021

Introduction

How We Operate.....	3
Benefits of a Ventilated Wall System	4-5
SILBONIT™ Cladding Sheets.....	6

Preparation

Before You Begin.....	7
Accessories	8
Fabrication	9
Cleaning	10
General Information.....	11

Installation Instructions

General Information.....	12
Installation on Wood	13
Installation on Steel.....	14
General Fixing for Steel Furring.....	15
Attaching Large Panels for Steel.....	16
Attaching Small Panels for Steel.....	17

Installation Details

Windows & Doors	18
Top, Bottom & Exterior Wall.....	19
Corners.....	20
Joints.....	21
Weather Boarding.....	22

Miscellaneous Information

Release Form	23
Warranty.....	24

Introduction • How We Operate

Lead Times - Our products are imported from Europe, which can result in a 12-16-week lead time. We can only estimate the delivery date that the material will be available. We hold no responsibility for importing delays. If you would like to reserve material a 50% deposit is required. A 25% restocking fee is issued for all cancelled orders.

Samples - We will gladly send you a complimentary sample box containing color samples of the material, small samples of the accessories and a Product Guide (if requested). The Product Guide contains all our literature and installation instructions and is always available online.

GET A FREE SAMPLE at <https://cementboardfabricators.com/sample-request>

Quotes - CBF will gladly assist in budgeting by providing a formal quote for your project. We can produce a quote from an estimated square foot surface coverage, or from the detailed needs of the specific project (including fabrication if needed). CBF does not do take offs or shop drawings; this is the responsibility of the client.

Placing the Order - When placing an order please specify quantity, color, steel or wood furring, & what color screw head. The rubber EPDM gasket strips are required in all exterior applications. CBF will calculate the amount of EPDM & screws needed for your project.

Release Form - All customers must complete and return the release form found on page 23. This form states that the customer is aware that the material must be installed per the installation instructions in order to validate the warranty. This form must be notarized & returned to CBF before the order will be released.

Cutting & Drilling - We will gladly fabricate the panels per your cut list. Dimensions & quantities will be needed to calculate the linear foot cutting charge that will be applied (please call for pricing). CBF reserves a cutting & drilling tolerance $\pm 1/8"$ & $\pm 3/16"$ of material squared tolerance. We require payment in full before any fabrication of any order. CBF requires dwg or dxf files for drilling. A formal cut list in an Excel file will be required for cutting. (a sample cut list form will be provided)

Payment - We accept Visa, MasterCard, American Express, or a company check may be mailed. If the material is not in stock, the customer may put 50% down to reserve material from our next incoming shipment. The other 50% will be due before the material can ship. If the material is in stock, & can be shipped immediately, we require payment in full before the material is shipped.

Delivery - The material is shipped by semi-truck. It is the responsibility of the customer to secure a method of unloading the material upon receipt. Please have this information available when setting up shipment. The panels must be stored indoors & CANNOT be allowed to get wet/damp in any way while stacked. This will damage the panels & void any warranty claim.

2148 S. 41st Street • Louisville, KY 40211
1-800-366-5378 • cementboardfabricators.com



Introduction • Benefits of a Ventilated Wall System*

Legend

- ① Cement Board
- ② Air Gap
- ③ Vertical Furring
- ④ Membrane
- ⑤ Sheathing
- ⑥ Interior Stud
- ⑦ Drywall

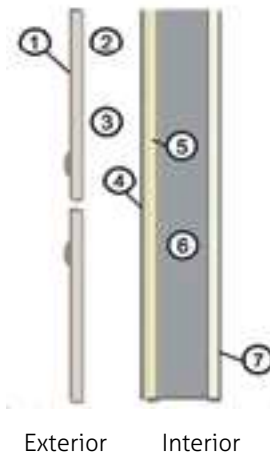

Climate Considerations*

Proper functioning of the ventilated wall must be studied in relation to the building's design & the climatic conditions in which the building is located. Some materials will work better than others in certain regions, & it is the responsibility of the architect/engineer to establish the proper materials for their specific project.

Summer

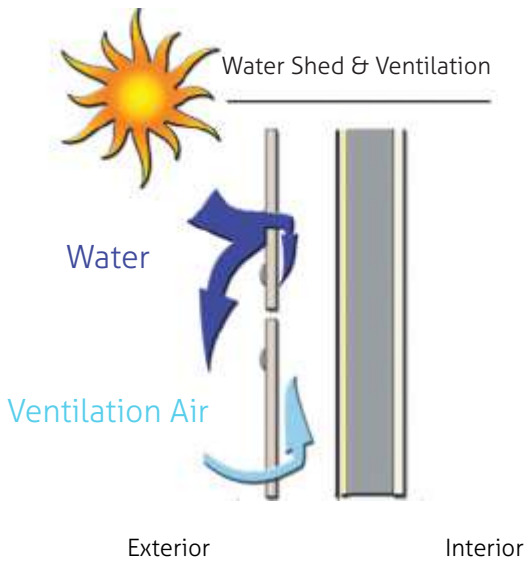

In the summer the ventilated wall is an exceptional reflector of solar radiation. The heat is accumulated on the surface layer & is not passed onto the underlying layers. The heat then escapes the wall thanks to the free-flowing air (The Fireplace Effect).

The air gap also helps to prevent the water from spreading inward to the underlying layers. Most of the water will run down the face of the material & most of what does get into the air gap will run down the back of the panel. The water will then evaporate & will be able to escape the wall thanks to the free-flowing air (The Fireplace Effect).

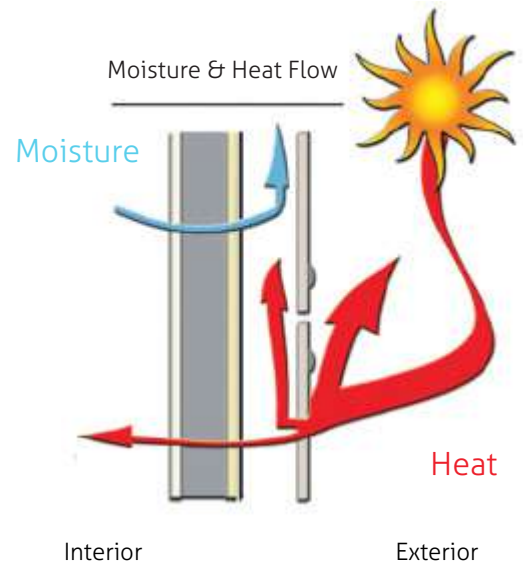

Introduction • Benefits of a Ventilated Wall System*

Legend

- ① Cement Board
- ② Air Gap
- ③ Vertical Furring
- ④ Membrane
- ⑤ Sheathing
- ⑥ Interior Stud
- ⑦ Drywall

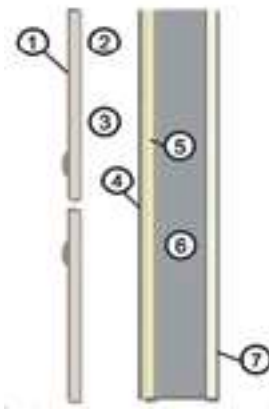

Exterior Interior

Climate Considerations*

Proper functioning of the ventilated wall must be studied in relation to the building's design & the climatic conditions in which the building is located. Some materials will work better than others in certain regions, & it is the responsibility of the architect/engineer to establish the proper materials for their specific project.

Winter

In the winter the vapor pressure inside heated structures are usually higher than outside, this could lead to the transportation of partial vapor pressure through the outside wall. The moisture is then eliminated by the free flowing air through the cavity.

The air gap also helps to prevent the water from spreading inward to the underlying layers. Most of the water will run down the face of the material & most of what does get into the air gap will run down the back of the panel. The water will then evaporate & will be able to escape the wall thanks to the free-flowing air.

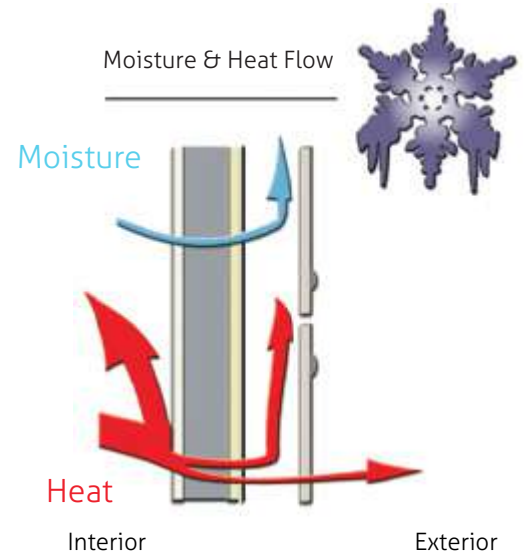
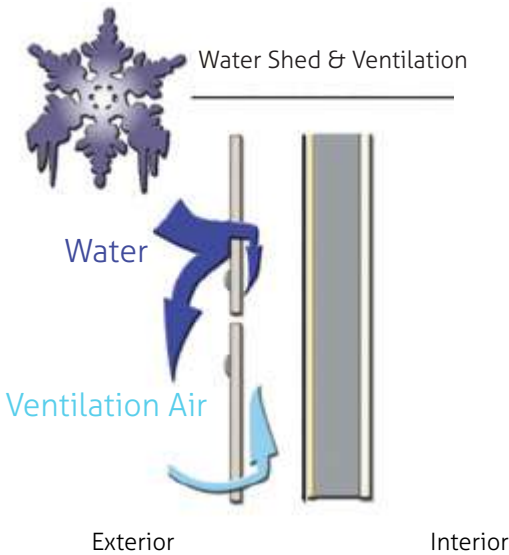

2148 S. 41st Street • Louisville, KY 40211

1-800-366-5378 • cementboardfabricators.com

Introduction • SILBONIT™ Cladding Sheets

Applications

SILBONIT™ cladding sheets are specially designed for external cladding, semi-exposed & external lining applications. Applied on a ventilated facade our fiber cement products are a strong, durable & lightweight material, which provides an attractive cost-effective solution for a wide variety of projects.

Composition

SILBONIT™ cladding sheets belong to the new generation of asbestos free compressed & stabilized flat sheeting reinforced with mineralized cellulose fibers. The sheets are non-combustible & resistant to rot, fungus & vermin attack.

Color / Finish

SILBONIT™ cladding sheets are available in many beautiful colors. It is important to note that the non-uniformity along with fading of the color & the presence of little imperfections are considered a common characteristic of the product & is not a defect as the panels are like a natural stone & does not look like an artificial product with an unnatural surface. These characteristics do not constitute a warranty claim & will not be entertained as such. The sheet is through colored & has impermeability.



Material Characteristics

Due to the nature of fiber cement products there will be variations in color as well as small imperfections ranging in size from a pin point to a dime. The color variations may be apparent within each board & from board to board. The color variations in the surface and natural aging of the panel will develop further as time passes. These characteristics mentioned above do not constitute a warranty claim & will not be entertained as such.

Sheet Sizes

The sheets are manufactured sizes of 49 1/4" x 96" & 49 1/4" x 120". The sheets may be ordered as a true 48" x 96" (4' x 8') or 48" x 120" (4' x 10') from the manufacturer. Our cutting service can fabricate the material to meet your project's specific needs. CBF reserves a tolerance +/- 1/8" cutting & +/- 3/16" of material squared tolerance.

Thicknesses

The panels weigh 3lbs per square foot for the 5/16" thickness.

Maintenance

SILBONIT™ cladding sheets require no regular maintenance to uphold their strengths, qualities & functions. When using our materials, please remove any dirt, dust, fingerprints, etc. from the face of the panel after fabrication & installation. Over time if the panels do happen to get dirty, a simple washdown with water & a mild detergent (Dawn dish soap) is usually sufficient.

SILBONIT™

The Colors of Nature

Iceberg Stone Desert Almond Coral Ash Gold Olive Bark Chestnut



Preparation • Before You Begin

Receipt of Material

Any damages or deviations must be immediately specified IN WRITING on the bill of lading when the delivery driver is still present. A copy of the bill of lading, with any remarks, must be submitted to the driver at the time of delivery.

Access to the job site must be such that deliveries can be made by a full 18 wheel flat-bed, or an enclosed tractor trailer. When placing the order please specify if you are able to unload an enclosed trailer, or if you will require a flat-bed delivery.

The job site must have access to accommodate an 18 wheel flat bed or enclosed tractor trailer. When placing an order please specify if you are able to unload an enclosed trailer or flat bed delivery. Smaller trucks can be arranged if needed.



It is the recipient's responsibility for unloading the material, & provisions must be arranged prior to the delivery. The delivery driver is not allowed to assist in unloading the material. The delivery driver will call 24 hours before making the drop to schedule the delivery.

Inspection of Material

It is the recipient's responsibility that all the materials are not damaged & in accordance with the order submitted. Any damages must be immediately documented in writing on the bill of lading while the delivery company employee is still present. Photos are required at that time for further documentation of damage.

CBF must be notified & provided with a copy of the bill of lading the same day as the delivery. Materials may only be returned after the freight claim is submitted.

Storing the Material

The material must be kept in a dry, well ventilated area, raised off the ground, & on a dry level surface at all times. Extended storage (more than two weeks) must take place in a dry ventilated building, & the plastic wrap should be removed. The panels must always be stored raised off the ground with supports at a maximum of 19", & always stacked with the edges directly over each other. The accessories should also be protected against dirt & precipitation. Flat panels that get wet due to precipitation or condensation will precipitate calcium/efflorescence, & will result in permanent damage that would not occur when properly stored or in proper use. If the boards do get damp when stacked, individually place the panels on their edge to ensure rapid drying & good ventilation. NEVER cut, drill, or install when the material is damp or in damp conditions.

Handling the Material

The material must be handled with care as to not damage the face, the corners or the edges. While handling the material you must also take care as to protect the panels against dirt & moisture as this will damage the material. Do not stack wet or dirty boards, as this will result in permanent damage that would not occur if properly handled.

The sheets must be lifted & not dragged off the stack, as this can result in damage to the material.

The sheets must also be carried by two people, & by the edge to reduce the strain on the material & the workers.



CORRECT



INCORRECT



CORRECT



INCORRECT

Wind & Water Barrier

There must be a wind & water barrier behind the facade cladding that is designed to make the structure impervious to the weather & the wind. Water will penetrate our facade cladding so it is extremely important to ensure that your wall is 100% waterproofed by the membrane. This product should be a breathable waterproof membrane to protect the substrate from damaging moisture from the weather, as well as allowing the building to breathe and the condensation within the structure to escape. Wind & Water Barrier supplied by CBF.

Supports / Furring Strips*

Regardless of the construction, our cladding sheets must be fastened to supports of sectional wood or steel. The depth of the strips must create a minimum 3/4" hollow air grip from back of our panels to the substrate.



STEEL

Minimum Dimensions

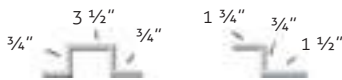

When using steel furring you may use hat channels, z-furring, or a combination of the two. The steel furring must be 18 gauge.



WOOD

Minimum Dimensions

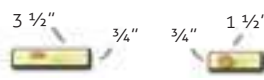

When using wood we recommend painting the lumber black with an exterior grade paint or wrapping it with the weather barrier. This will not only help to preserve the wood, it will also hide the wood in the horizontal gaps.

- * The maximum length of any furring strip is 10ft.
- * NEVER use a combination of wood & steel furring.
- * It is the client's responsibility to choose the correct wood product.
- * The use of treated lumber is not recommended.
- * Specific static calculations must comply with local regulations.
- * This Item is not supplied by CBF.

EPDM Rubber Strips**



DIMENSIONS

3 1/2" x 1/8"

1 1/4" x 1/8"

The EPDM rubber strips must always be used on the supporting structure of wood or steel furring strips, & are applied as a direct base for our material. You may staple or use a spray adhesive to attach the EPDM rubber strips to the furring strips. These strips not only help to protect the furring, but also aid in the movement of our material. The wider strips are applied on the furring at the vertical joints & the narrower strips are applied on the furring in the field of the material. ** This item is supplied by CBF.

Stainless Steel Screws**

The panels are secured to the supporting structure using exposed stainless steel pan head screws. The screw spacing will be determined by the furring style used. Please refer to the installation instructions on page 13 & 14. The screws cannot be countersunk because the panels need movement to succeed.



WOOD

STEEL

You will be supplied with one driver per every 250 screws. All our screws for steel are self drilling.

DO NOT OVERTIGHTEN THE SCREWS



Over tightening screws will restrict the movement of the panels, which will crack the panels.

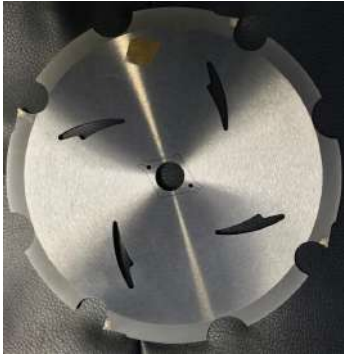

Cutting the Material*

We can supply you with the correct saw blades



CBF will fabricate the order per your cut list. Our facilities are equipped with two industrial stone saws. Our fabrication is done with a 20" segmented diamond blade to ensure accurate lines and measurements. This blade leaves a sharp edge with minimal chipping. The correct diamond blades and drill bits are available for purchase from our facility. The fabrication must be done with the finished side facing up. If larger holes are needed use a diamond tipped hole saw. For cuts that don't require a sharp edge, jigsaws with a carbide tip are required. It is imperative to only work with dry material and in dry conditions. Working with damp panels or in damp conditions will cause dust from the fabrication to "burn" into the panel and will leave permanent stains. Do Not use any tapes on the face of the panels (e.g. adhesives, painter's tape etc...). Failure to follow these instructions will void any warranty claims.

Drilling the Material

The holes must be pre-drilled from the finished side of the material facing up using carbide tipped drill bits. (CBF can drill the material with dwg or dxf files.) The holes must be drilled larger than the shaft of the screw to allow for movement of the panel.



Only work with dry material & in dry conditions. Working with damp material or in damp conditions will cause the dust to permanent "burn" into the material & leave permanent stains.

Steel Furring

When using steel furring strips there must be one fixed point near the center of the board with a 7/32" drill bit. The other dilation points will be oversized using a 9/32" drill bit.

Wood Furring

When using wood furring strips you will only have dilation points using a 9/32" drill bit, which are all oversized.

Completion of Work

When the installation is complete check to ensure the cladding is clean and without damage, defects, or omissions. It is important that you remove any dust from the face of the panels before installing to avoid the dust from permanently burning into the material.



(Dust from cutting the edge)

Please refer to the Fabrication & Cleaning Checklist located on page 10. Please contact CBF if further cleaning instructions are needed.



FABRICATION & CLEANING CHECKLIST

• Exterior Field Application

- Place the panel finished side facing up at the desired fabrication space.
- Mark the appropriate cut & drill areas. Do not use adhesive tapes to mark your lines.
- Cut & Drill the material finish side facing up (using a vacuum device to collect dust).
- Cleaning the cut edges of the panel may require a light sanding with an 80-100 grit sanding block.
- Vacuum all remaining dust & reminisce off the panel. Be sure not to scratch the panel face, a soft bristle attachment works well.
- Remove any dust from the surface of the panel, even using a standard vacuum cleaner, be sure not to scratch the panel a soft bristle works well.
- If dust persists, blow with low-pressure air and use a clean microfiber cloth without rubbing removing all dust prints.
- Repeat steps after each panel is installed
- Once the panel is fabricated & thoroughly cleaned, make sure it is dry before stacking.

► For interior applications skip Step #9 & follow all other steps.

FAILURE TO FOLLOW THESE INSTRUCTIONS WILL CAUSE DAMAGE TO PANEL CALLED A "BURN" & WILL RUIN APPEARANCE & CANNOT BE REPAIRED.

Attention to Details



In order to achieve a good result the panels must be installed on a stiff, strong, flat & level construction. The wall's stability must be ensured without help from our products. Attention to detail is of MAJOR importance, so it is therefore important that the joints & connections of the cladding are solved and completed with precision & care.

Since our products will move when the climate changes, they may bend +/- 1/4".



Ventilated Construction

Our facade cladding must always be installed as a ventilated construction with the outermost cladding open in order to allow ventilation of an underlying cavity. There must be a minimum 3/4" hollow air gap between the substrate & the back of our panels. You must also allow for a 5/16" gap between sheets in both the vertical & horizontal joints, as well as a 3/4" gap at the very bottom of the wall & at the soffit/cap.



This ventilation is an upgoing air flow from the bottom of the wall to the soffit/cap & this air gap is not to be blocked at any point. There must also be a minimum 1/2" through going air gap on each height between floors (a 1/2" gap between the furring strips).

The ventilation equalizes the changes in pressures, which can be caused by gusts of wind, climate change, or drying of the panels, as well as ensuring humidity & condensation from both inside and outside the structure is able to escape.

Safety



Inhalation: Acute over-exposure to dust may cause mild irritation & inflammation of the respiratory tract & organs. Use approved respiratory equipment when airborne dust is present. We advise the use of a dust extractor & a mask when cutting with power tools. If irritation occurs, get into fresh air. If condition persists, seek medical advise.



Eye Contact: You may experience a mild discomfort of the eyes caused by the dust. Always wear safety goggles when cutting or drilling the material. If an irritation occurs, flush with plenty of fresh water, & seek medical attention if condition persists.



Skin Contact: Prolonged contact may cause a mild irritation. You should always wear gloves when handling the material. If an irritation occurs, wash hands thoroughly with water.

Although our products contain no asbestos, you should choose a working method which minimizes dust during installation.

Installation at a Glance

1. Apply the Breathable Waterproof Membrane.

2. Apply the Vertical Furring Strips of Wood or Steel.

3. Apply the EPDM Rubber Strips.

4. Apply the Fiber Cement Panels. Begin at the top of the wall & work down.

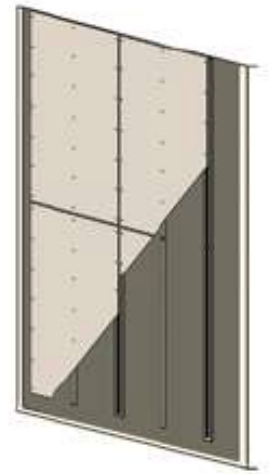

Installation of Screws

The screws are installed in a spiral manner. You apply the center screw first, then continue in a spiral manner.

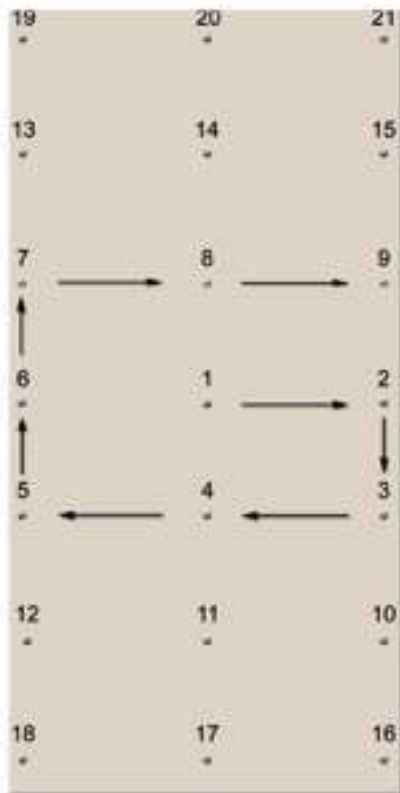

This image is for demonstration purposes only.

Unsupported Panel

- ① ¾" Spacer
- ② EPDM Rubber Strip
- ③ Fiber Cement Board
- ④ Stainless Steel; Pan Screw Head
- ⑤ 2" max. Unsupported Board

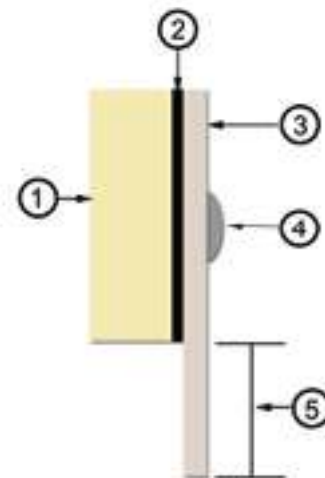

Installation Instructions • Installation on Wood Furring

- ① Breathable Waterproof Membrane
- ② ¾" x 3 ½" Minimum Spacer
- ③ ¾" x 1 ½" Minimum Spacer
- ④ 3 ½" EPDM Rubber Strip
- ⑤ 1 ¼" EPDM Rubber Strip
- ⑥ ⅝" Gap Between Sheets
- ⑦ Stainless Steel; Pan Head Screw

Legend

- ⑧ 1" Minimum Screw Distance from Vertical Edge*
- ⑨ 2 ¾" Minimum Screw Distance from Horizontal Edge*
- ⑩ 16" or 24" Spacer Distance in Vertical Plane (facade)
16" Maximum Spacer Distance in Horizontal Plane (soffit)
- ⑪ 16" or 24" Screw Distance in Vertical Plane ≤ 8 Floors
16" or 24" Screw Distance in Vertical Plane ≥ 8 Floors
Furring 1-1/2 min. > 8 Floors in Vertical Plane

All spacer distance must be approved by a structural engineer

** 4" Maximum distance from the vertical & horizontal edges.*

Horizontal Elevations

(All Drawings are not to Scale)

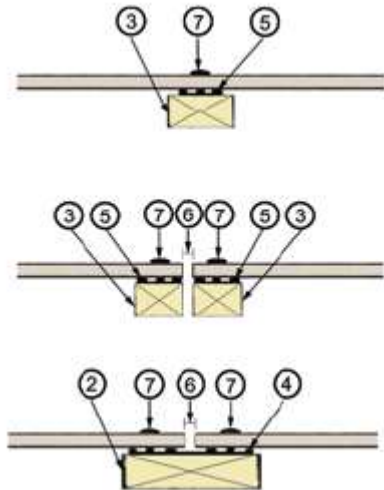

- The spacers may never be longer than 10'.
- There must be a 1/2" gap between the spacers.

- All holes must be predrilled oversized using a 9/32" carbide tip drill bit.
- Remember to install the center screw first then continue in a spiral.

- The screws should only be snug against the panel & not screwed in as tight as possible.
- Overtightening the screws will restrict movement & destroy the board.

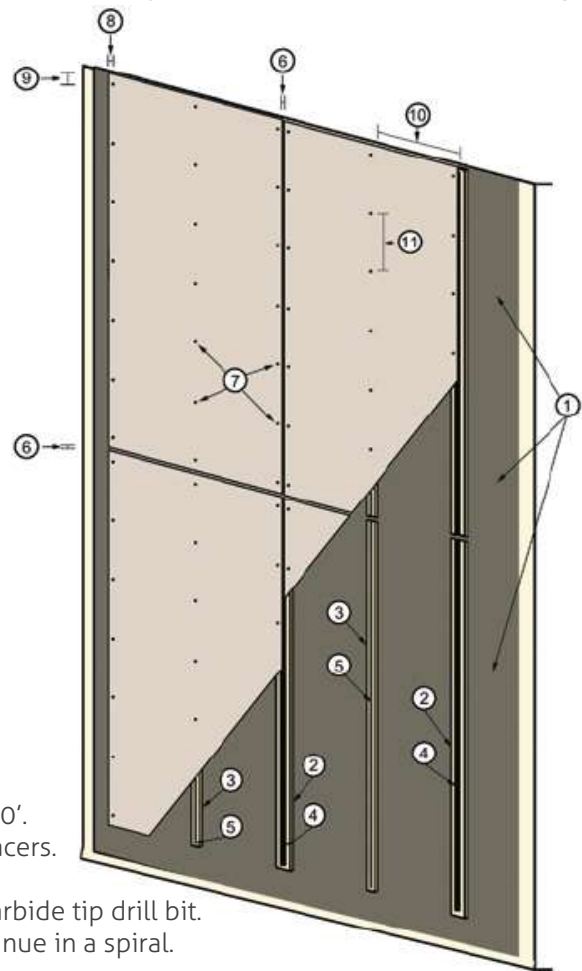

Installation Instructions • Installation on Steel Furring

Legend

- | | |
|---|--|
| <ul style="list-style-type: none"> ① Breathable Waterproof Membrane ② Steel Hat Channel** ③ Steel Z-Furring Channel** ④ 3 ½" EPDM Rubber Strip ⑤ 1 ¼" EPDM Rubber Strip ⑥ 5/16" Gap Between Sheets ⑦ Stainless Steel; Pan Head Screw | <ul style="list-style-type: none"> ⑧ 1" Minimum Screw Distance from Vertical Edge* ⑨ 2 ¾" Minimum Screw Distance from Horizontal Edge* ⑩ 16" or 24" Spacer Distance in Vertical Plane (facade)
16" Maximum Spacer Distance in Horizontal Plane (soffit) ⑪ 16" or 24" Screw Distance in Vertical Plane ≤ 8 Floors
16" or 24" Screw Distance in Vertical Plane ≥ 8 Floors
Furring 1-1/2 min. > 8 Floors in Vertical Plane <p><i>**All spacer distance must be approved by a structural engineer**</i></p> <p><i>* 4" Maximum distance from the vertical & horizontal edges.</i></p> |
|---|--|

Horizontal Elevations

(All drawings are NOT to scale)

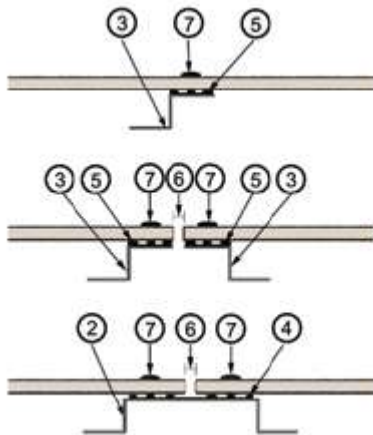

- The steel must be 16 or 18 gauge.
- The dilation points must be pre-drilled oversized using a 9/32" carbide tip drill bit with the center screw being the fixed point using a 7/32" carbide tip drill bit.

Remember to install the center screw first then continue in a spiral. The screws must not be over tightened. Over tightening the screws will restrict the panel's movement & will cause cracking.

- The spacers may never be longer than 10'.
- There must be a 1/2" gap between the spacers.

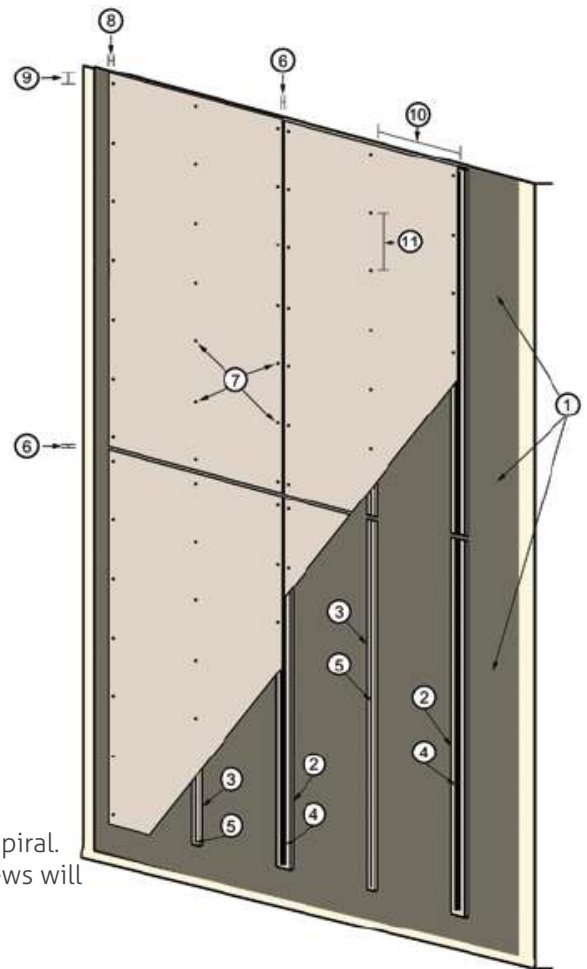

**See Pages 15-17

Installation Instructions • General Fixing for Steel Furring

STEEL FURRING ONLY

(See pages 16-17)



ALLOWED



NOT ALLOWED



III AD Architects & Design, [www.3-ad.com] Spitzack / Vice photo by Jayme Halbritter Photography

Installation Instructions

- Attaching Large Panels for Steel Furring

Vertical Panels on Steel

(4' x 8' panels shown here)

Drawings NOT to scale

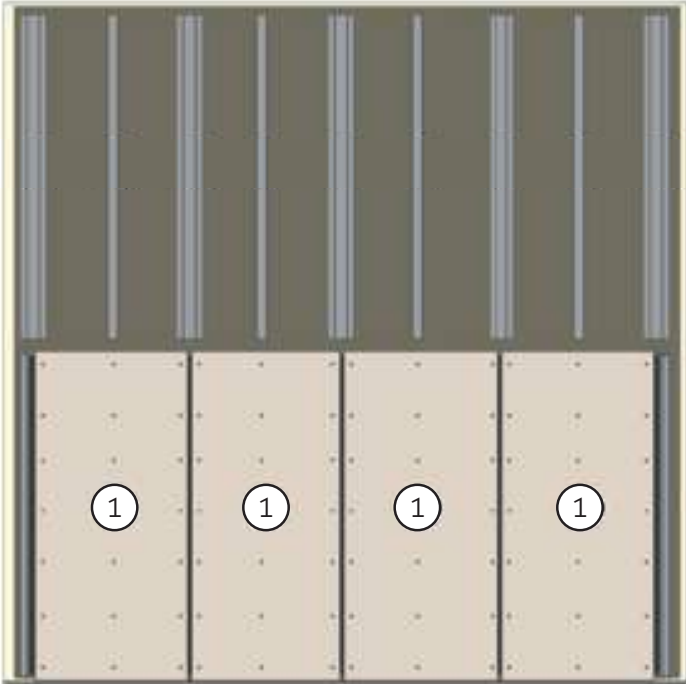

Horizontal Panels on Steel

(4' x 8' panels shown here)

Drawings NOT to scale

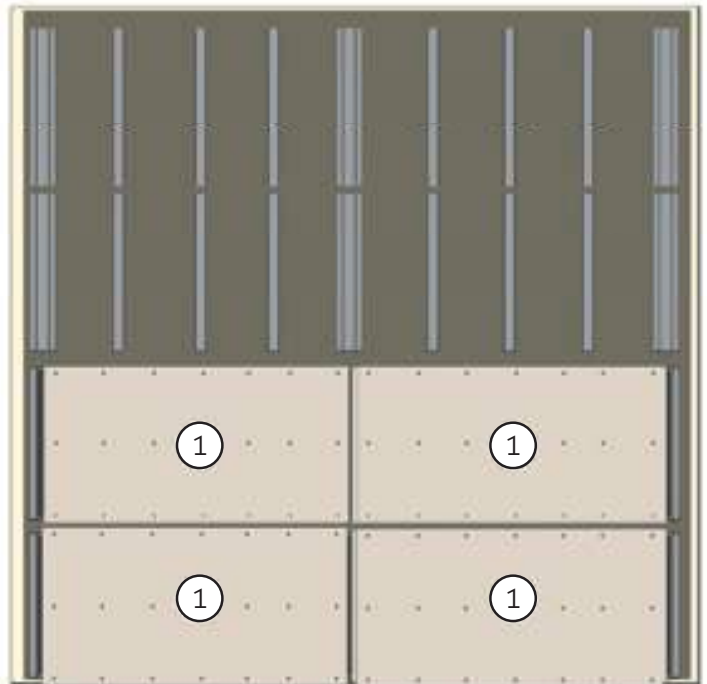

Vertical Panels on Steel

(2' x 8' panels shown here)

Drawings NOT to scale

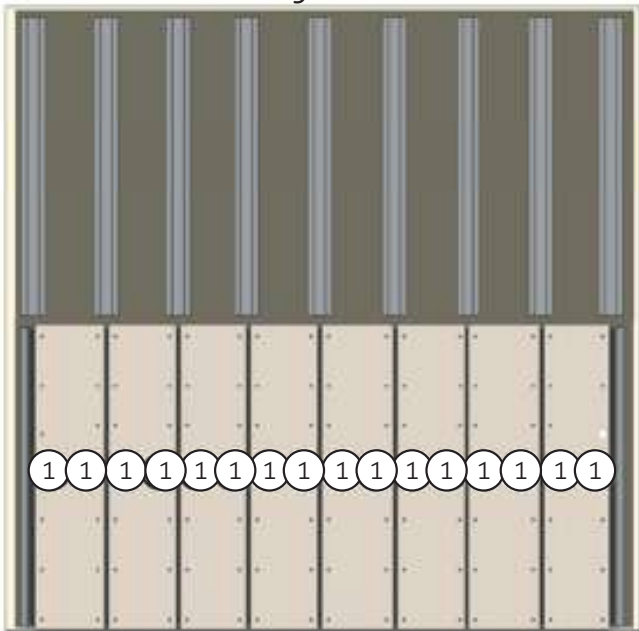

Horizontal Panels on Steel

(2' x 8' panels shown here)

Drawings NOT to scale

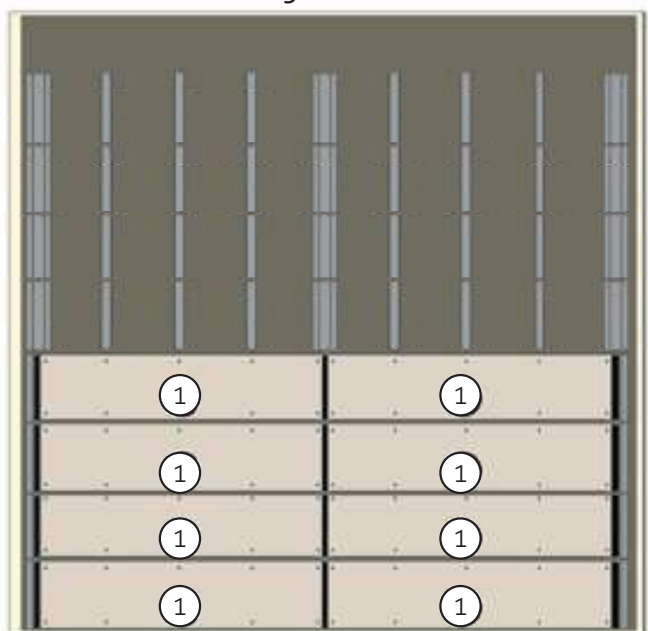

Legend



Fixed Point of Panel on Steel Furring**

** All other attachments of panel are oversized.

- Call your local steel furring supplier for the correct securing applications.

Installation Instructions

- Attaching Small Panels for Steel Furring

Vertical Panels on Steel

(2' x 4' panels shown here)

Drawings NOT to scale

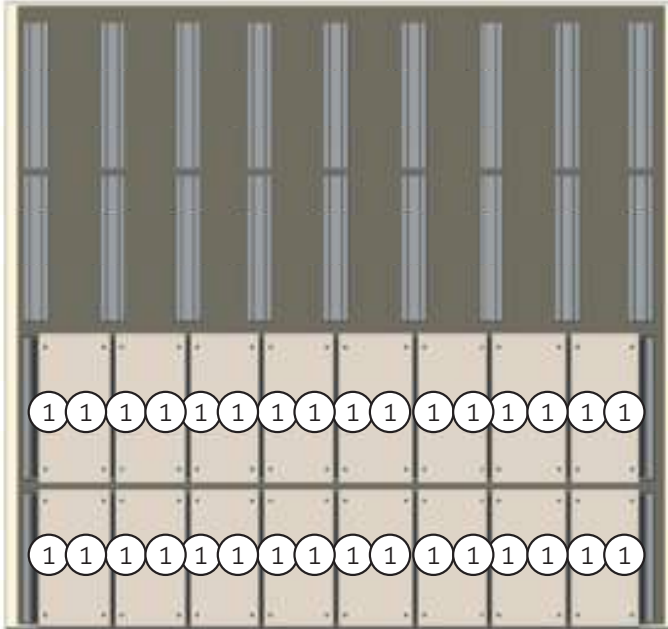

Horizontal Panels on Steel

(2' x 4' panels shown here)

Drawings NOT to scale

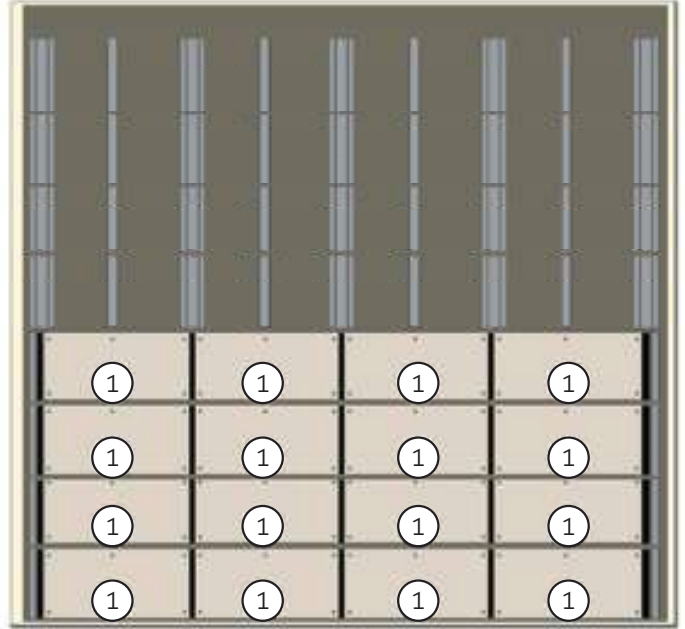

Vertical Panels on Steel

(4' x 4' panels shown here)

Drawings NOT to scale

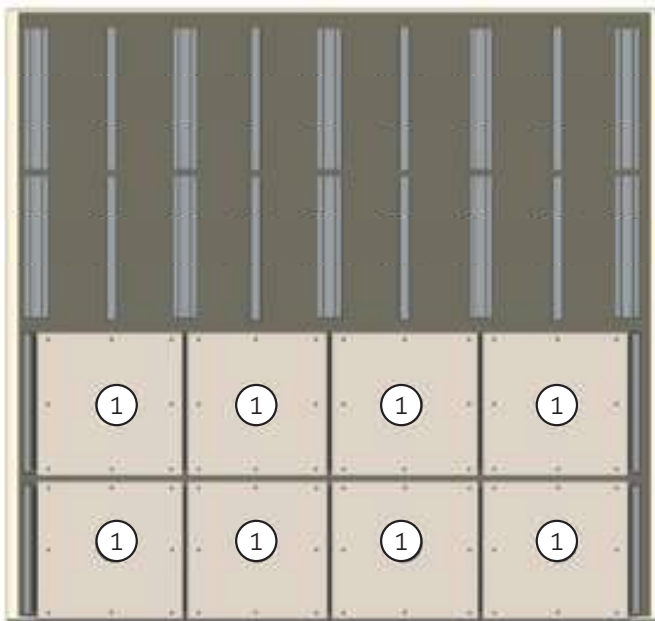

Horizontal Panels on Steel

(2' x 4' panels shown here)

Drawings NOT to scale

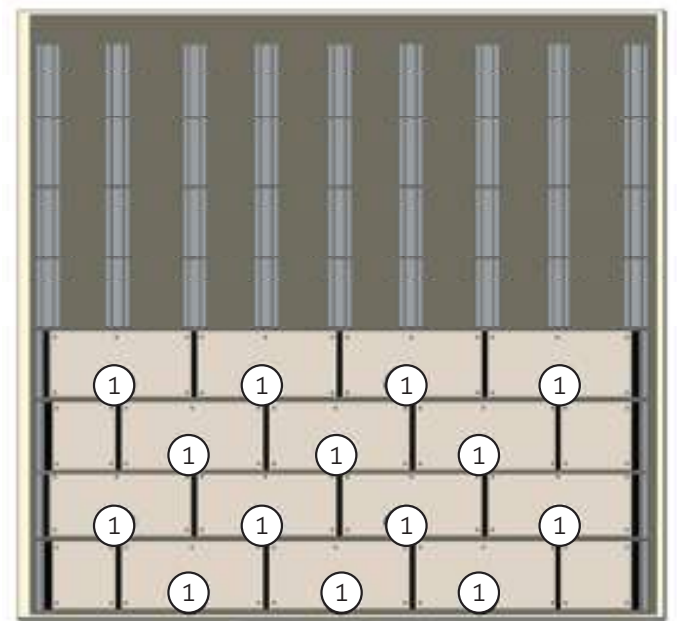

Legend



Fixed Point of Panel on Steel Furring**

** All other attachments of panel are oversized.

- Call your local steel furring supplier for the correct securing applications.

Installation Details • Door & Window Solutions

Legend

- | | | |
|-------------------------------------|----------------------------------|--|
| ① Fiber Cement Cladding Sheets | ⑥ 1 ¼" EPDM Rubber Strip | ⑪ Insulation |
| ② Breathable Waterproof Membrane | ⑦ Stainless Steel Screw | ⑫ Vertical Batten |
| ③ ¾" Minimum Spacer for Ventilation | ⑧ Flashing | ⑬ Horizontal Batten |
| ④ Air Space | ⑨ ¾" Min. Distance from flashing | <i>*In window application
a minimum of 6" in L"
shaped cuts.</i> |
| ⑤ 3 ½" EPDM Rubber Strip | ⑩ Backer Rod & Sealant | |

Recessed Window Solutions

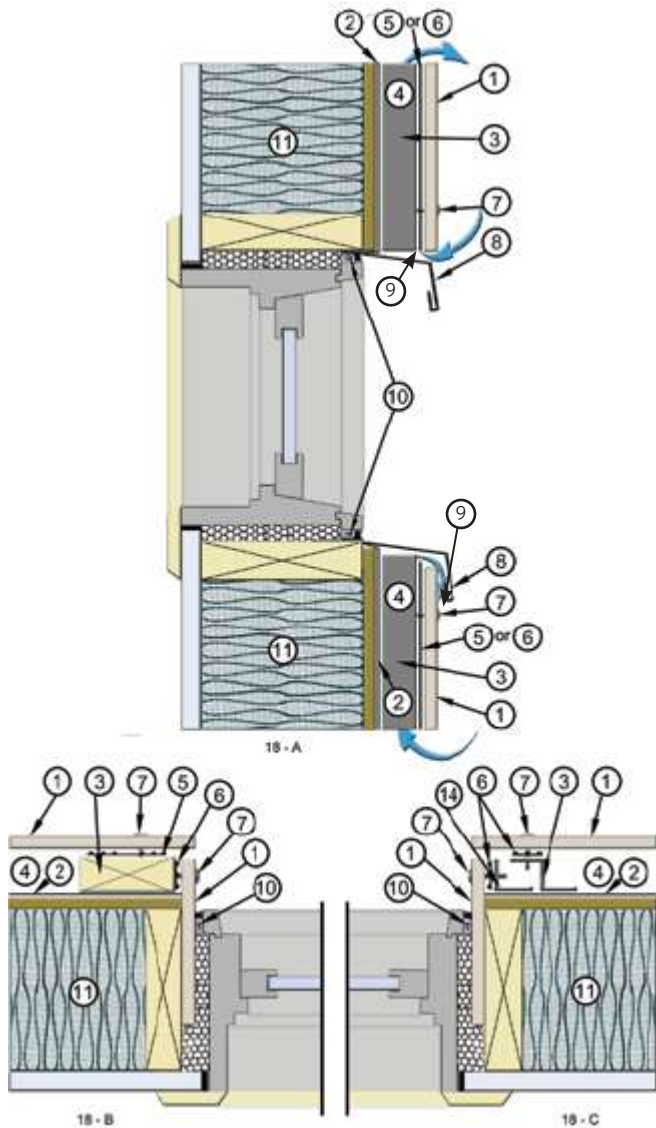

Flush Window Solutions

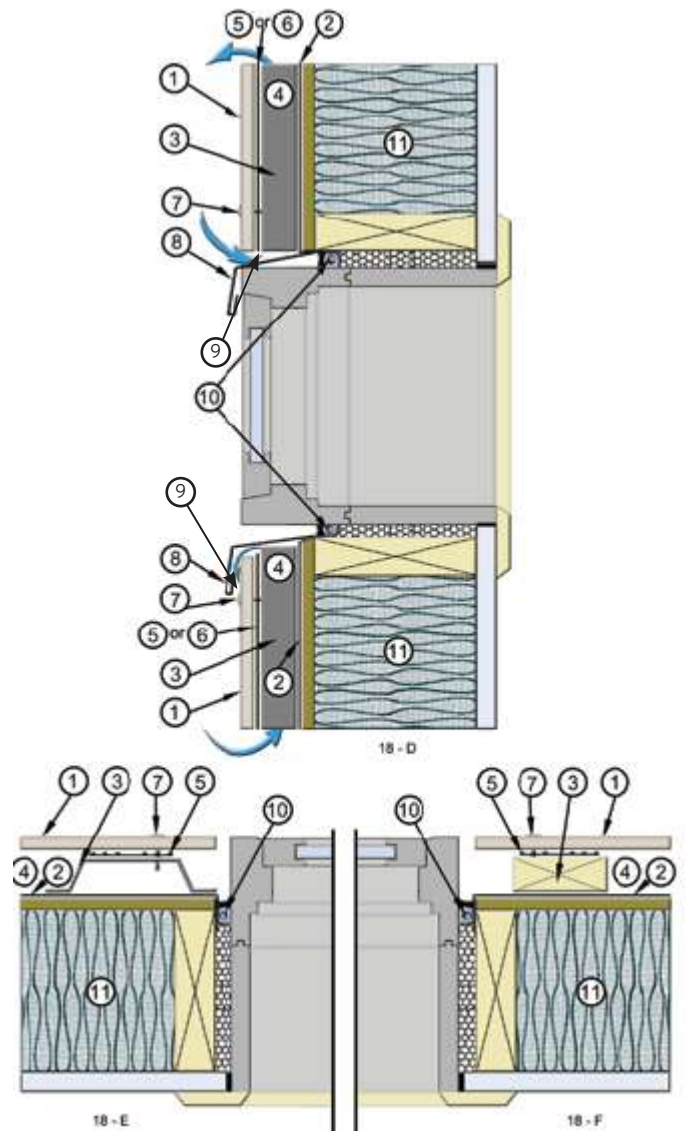

Installation Details • Top, Bottom & Exterior Wall Solutions

- | | | |
|-------------------------------------|--------------------------|----------------------------------|
| ① Fiber Cement Cladding Sheets | ⑤ 3 ½" EPDM Rubber Strip | ⑨ ¾" Min. Distance from flashing |
| ② Breathable Waterproof Membrane | ⑥ 1 ¼" EPDM Rubber Strip | ⑩ Backer Rod & Sealant |
| ③ ¾" Minimum Spacer for Ventilation | ⑦ Stainless Steel Screw | ⑪ Insulation |
| ④ Air Space | ⑧ Flashing | |

Legend

Soffit Solution

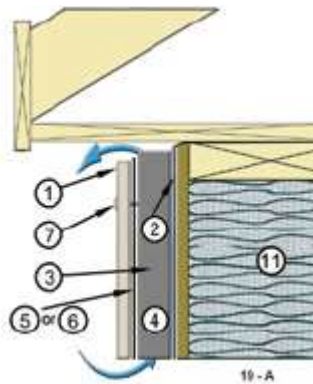

Cap Solution

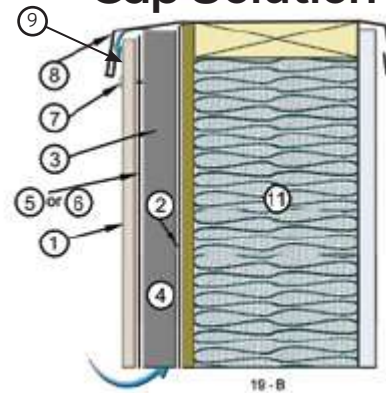

Exterior Wall Connection

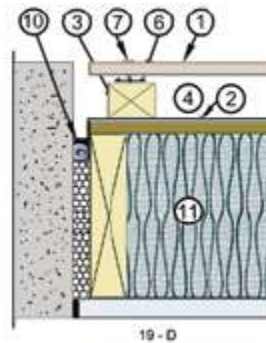
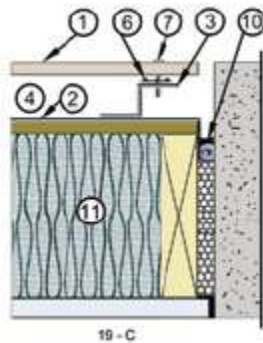

Socle Solution

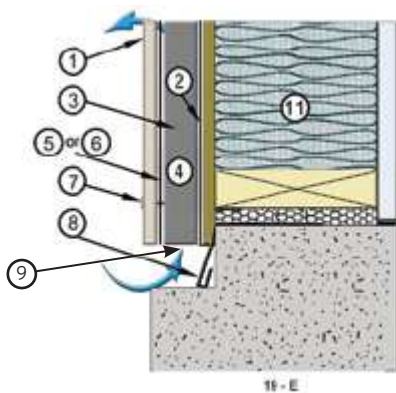

Socle Solution

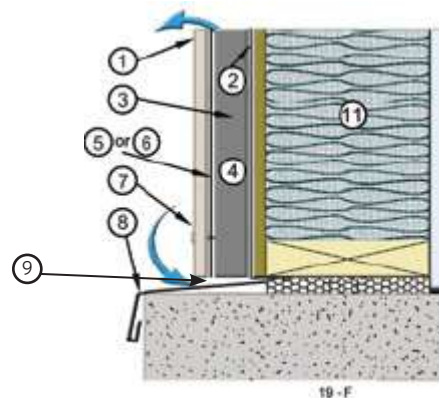

Installation Details • Corner Solutions

Legend

- | | | |
|-------------------------------------|--------------------------|---------------------|
| ① Fiber Cement Cladding Sheets | ⑥ 1 ¼" EPDM Rubber Strip | ⑪ Insulation |
| ② Breathable Waterproof Membrane | ⑦ Stainless Steel Screw | ⑫ Vertical Batten |
| ③ ¾" Minimum Spacer for Ventilation | ⑧ Flashing | ⑬ Horizontal Batten |
| ④ Air Space | ⑨ N/A | |
| ⑤ 3 ½" EPDM Rubber Strip | ⑩ Backer Rod & Sealant | |

Open Joints

Outside Corner

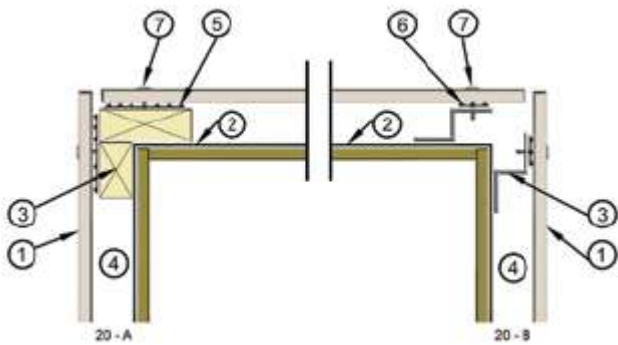

Open Joints

Outside Corner

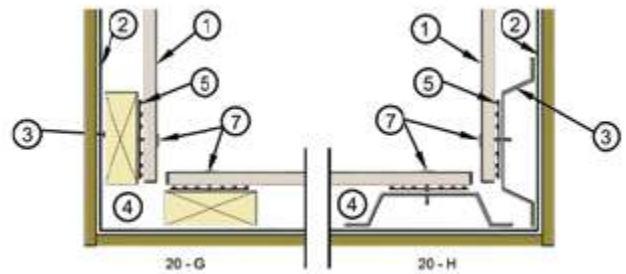

Wood Battens

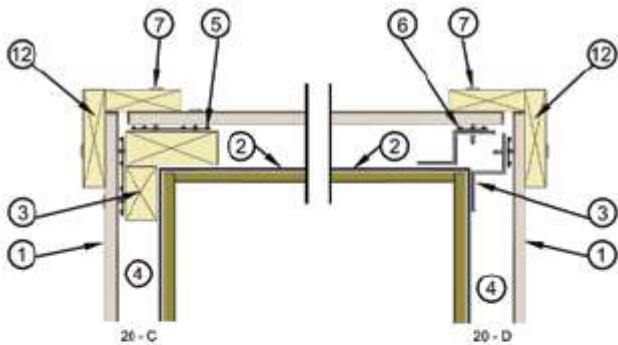

Metal/Plastic Flashing

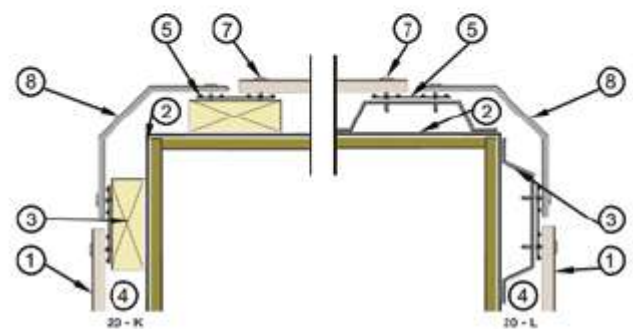
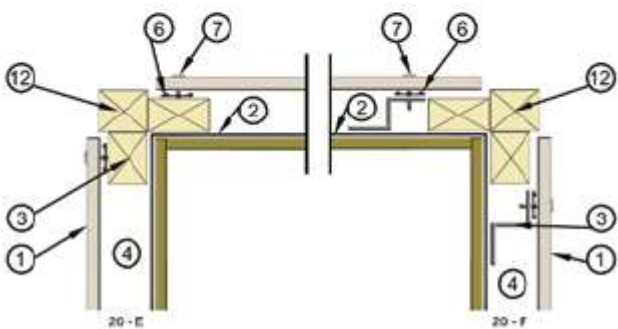
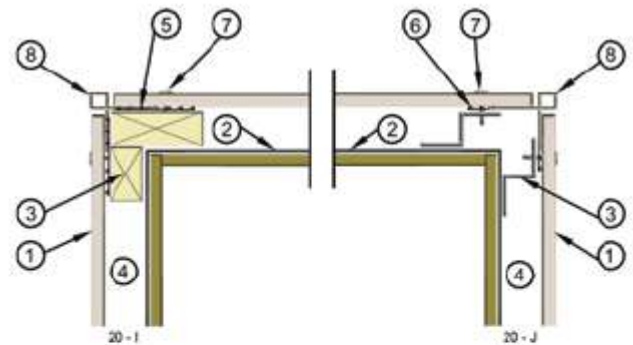

Installation Details • Joint Solutions

Legend

- | | | |
|-------------------------------------|--------------------------|---------------------|
| ① Fiber Cement Cladding Sheets | ⑥ 1 ¼" EPDM Rubber Strip | ⑪ Insulation |
| ② Breathable Waterproof Membrane | ⑦ Stainless Steel Screw | ⑫ Vertical Batten |
| ③ ¾" Minimum Spacer for Ventilation | ⑧ Flashing | ⑬ Horizontal Batten |
| ④ Air Space | ⑨ N/A | |
| ⑤ 3 ½" EPDM Rubber Strip | ⑩ Backer Rod & Sealant | |

Open Joint Solutions

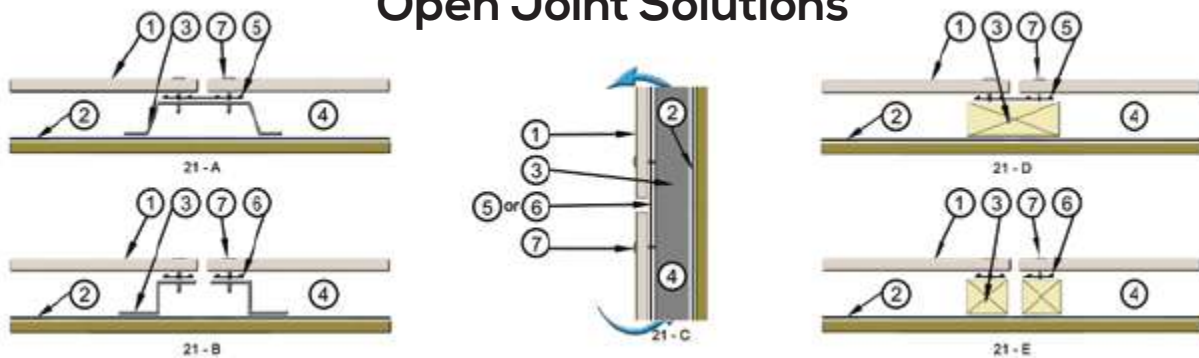

Covered Joint Solutions

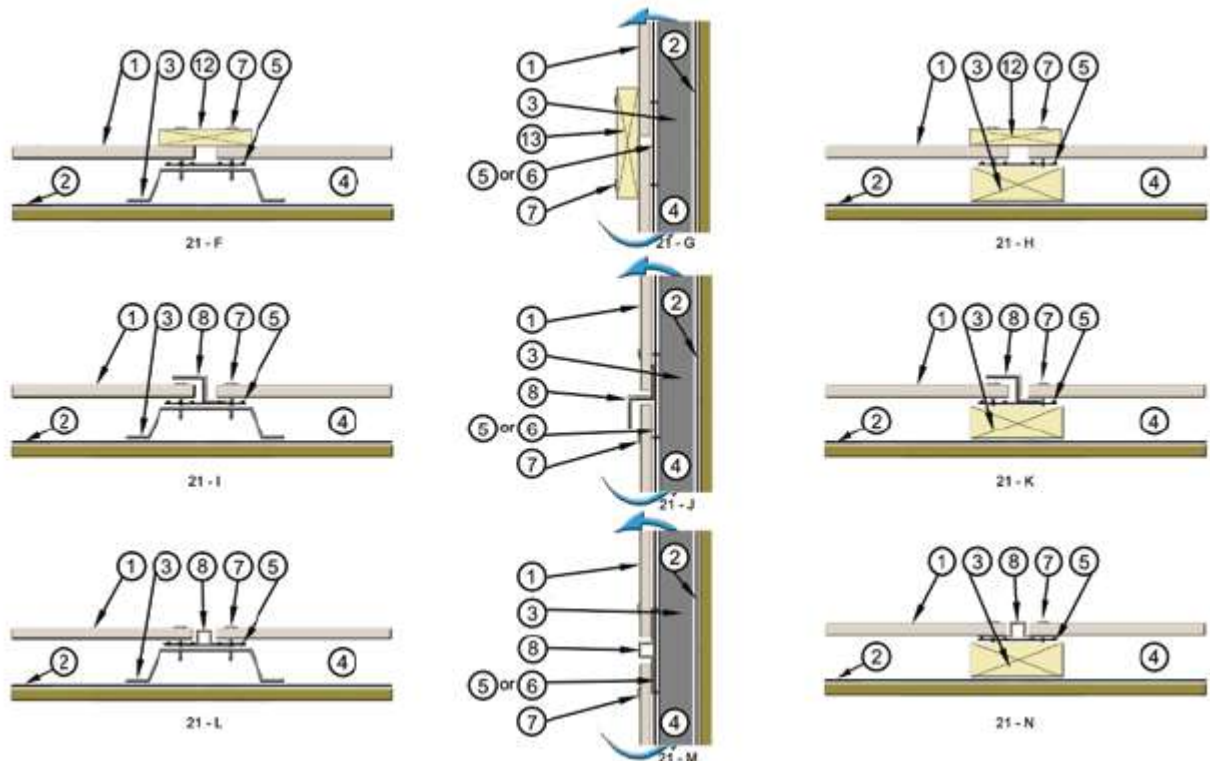

Installation Details • Weather Boarding*

Legend

- ① Fiber Cement Cladding Sheets
 - ② Breathable Waterproof Membrane
 - ③ ¾" Minimum Spacer for Ventilation
 - ④ Air Space
 - ⑤ 3 ½" EPDM Rubber Strip
 - ⑥ 1 ¼" EPDM Rubber Strip
 - ⑦ Stainless Steel Screw
 - ⑧ Flashing
 - ⑨ N/A
 - ⑩ Backer Rod & Sealant
 - ⑪ Insulation
 - ⑫ Vertical Batten
 - ⑬ Horizontal Batten
- *6 Minimum & 16" Maximum Board Size

Vertical Spacers

(Boards from 6" - 16")

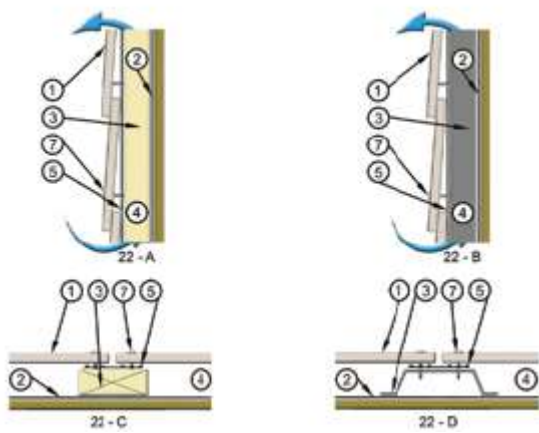

Vertical Spacers

(Boards from 6" - 16")

- Ⓐ ¾" x 3 ½" Minimum Spacer
- Ⓑ 1 ½" Minimum Distance (4" Maximum)
- Ⓒ 2 ¾" Maximum Distance
- Ⓓ 24" Max Distance
- Ⓔ 5/16" Gap
- Ⓕ See Chart Below
- Ⓖ 1" Minimum Overlap (2" Maximum)
- Ⓗ ¼" Minimum Distance of Screw from the Bottom Board

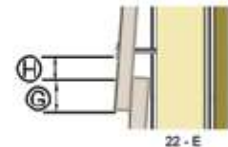

Building Height	< 66'	16"
Building Height	66' - 125'	12"

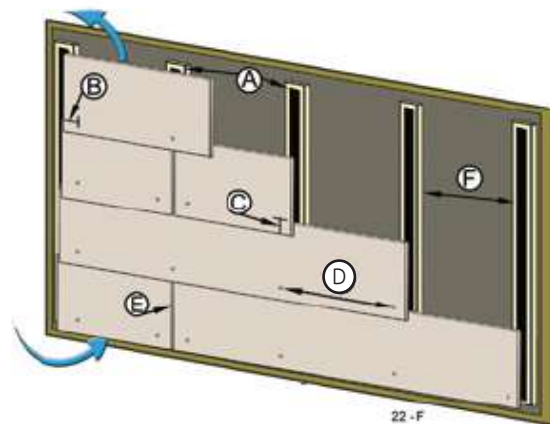

Miscellaneous Information • Release Form

I, We _____ acknowledge receipt of Cement Board Fabricators, Inc.'s Product Guide provided by Cement Board Fabricators Inc. to be used in the installation of the fiber cement panels, which shall be purchased from Cement Board Fabricators, Inc.

I, We also acknowledge that all of the specified accessories are to be utilized during the installation of the fiber cement panels.

I, We acknowledge & understand that any failure to follow each of the instructions contained in the Product Guide and any failure to utilize each specific accessory may result in the partial or total invalidation of the warranty.

Company

Project Name

Printed Name & Title

Project Address

Signature

Project City, State & Zip

Date

NOTARY

On this day of ____ / ____ / ____ before me, _____

personally appeared _____, to me known to be the person named in & who

executed the foregoing instrument & acknowledged that he executed the same as his free & voluntary act.

Notary Public

My commission expires _____



SILBONIT NATURAL

LIMITED WARRANTY

Cement Board Fabricators (CBF) warrants the Silbonit - Natural Finish distributed by CBF are free from defects in material and workmanship using manufacturers' specifications as a standard. Only products that are installed & used in accordance with applicable CBF instructions or specifications are warranted by CBF. All warranty claims must be made, in writing, within 30 days of discovery of the defect, or within ten years after the date of shipment of the product by CBF, whichever is later. Any claims made outside of this period are waived. If a claim is made under this warranty, you must allow for a reasonable inspection of the product you claim is defective & must provide samples that adequately demonstrate the problem which resulted in your claim for testing by CBF. CBF disclaims all implied warranties including the warranty of merchantability & fitness for a particular purpose or use. This warranty shall serve as the exclusive remedy for all claims arising from your status as a buyer of CBF products. This limited warranty may not be modified or amended except by a written agreement authorized & signed by an authorized representative of CBF. Without an express, written authorization from CBF, no retailer or distributor of CBF products has the ability to modify or amend this warranty.

LIMITATION OF LIABILITY

This limited warranty is your sole & exclusive warranty for all claims arising from your status as a buyer of CBF products, including defects in material & workman ship. It is expressly understood & agreed that the limit of liability will be, at CBF's option, repair, resupply of a like quantity of non-defective product, or refund of the purchase price of the material. **All labor and service charges which may be incurred with respect to either the original or replacement product are excluded.** CBF shall have no liability except where the claim results solely from breach of CBF's limited warranty. CBF shall not be liable for any incidental or consequential damages resulting from the purchase or use of CBF products. Furthermore, CBF shall not be liable for damage to the property to which any CBF product is applied or its contents, loss of time, profits, or any inconveniences arising out of any breach of this limited warranty or obligations under this limited warranty. CBF shall not be liable for damages which are based on negligence, breach of warranty, strict liability, or any other theory except as provided for in the Limited Warranty above. Incidental & consequential damages shall not be recovered even if the replacement remedy fails of its own purpose or for any other reason.

This limited warranty covers the structural or physical defects of the base material only. Alterations of the surface or damage due to external influences such as mechanical loads & defects from the use of improper accessories are **expressly excluded** from this warranty. **Changes in color/efflorescence on the boards (e.g. fading) are part of the normal aging & weathering process of cement based materials & are also expressly excluded from this warranty.**

Cement Board Fabricators • Product Guide



